

Product Summary

V_R	650V
$I_{F(110/143^\circ\text{C})}$	6.2A/4A*
Q_C	9nC



H3D065S004 H3D065K004

Features

- Low Conduction and Switching Loss
- Zero Reverse Recovery
- Temperature Independent Switching Behavior
- Positive Temperature Coefficient Device
- High Surge Current Capability
- RoHS Compliant and Halogen Free
- Suitable for High-Speed Application

Circuit Diagram



Benefits

- Higher System Efficiency
- Increase Parallel Device Convenience
- Enable High Temperature Application
- Allow High Frequency Operation
- Realize Compact and Lightweight Systems
- High Reliability

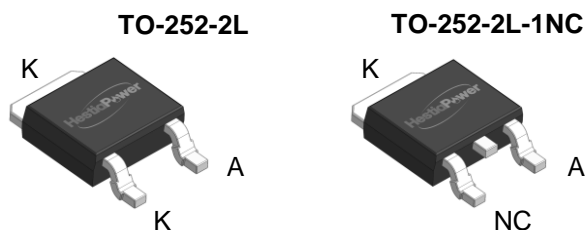

Applications

- Switching Mode Power Supply
- PFC
- UPS
- Motor Drives
- Flywheel diode in Power Inverters
- Solar/Wind Renewable Energy

Part Number	Package	Marking
H3D065S004	TO-252-2L	H3D065S004
H3D065K004	TO-252-2L-1NC	H3D065K004

Absolute Maximum Ratings ($T_C = 25^\circ\text{C}$ unless otherwise specified)

Parameter	Symbol	Test Conditions	Value	Unit
Peak Repetitive Reverse Voltage	V_{RRM}	$T_J = 25^\circ\text{C}$	650	V
Peak Reverse Surge Voltage	V_{RSM}	$T_J = 25^\circ\text{C}$	650	V
DC Blocking Voltage	V_R	$T_J = 25^\circ\text{C}$	650	V
Continuous Forward Current	I_F	$T_C = 25^\circ\text{C}$	10*	A
		$T_C = 110^\circ\text{C}$	6.2*	
		$T_C = 143^\circ\text{C}$	4*	
Non-Repetitive Peak Forward Surge Current	I_{FSM}	$T_C = 25^\circ\text{C}$, $T_P = 10$ ms, Half Sine Wave	26*	A
		$T_C = 125^\circ\text{C}$, $T_P = 10$ ms, Half Sine Wave	22*	
		$T_C = 25^\circ\text{C}$, $T_P = 10$ μs , Pulse	228*	
Repetitive Peak Forward Surge Current	I_{FRM}	$T_C = 25^\circ\text{C}$, $T_P = 10$ ms Half Sine Wave, $D = 0.1$	18*	A
		$T_C = 125^\circ\text{C}$, $T_P = 10$ ms Half Sine Wave, $D = 0.1$	14*	
Power Dissipation	P_D	$T_C = 25^\circ\text{C}$	33	W
		$T_C = 125^\circ\text{C}$	11	
I^2t value	$\int i^2 dt$	$T_C = 25^\circ\text{C}$, $T_P = 10$ ms	3.3*	A^2s
Junction & Storage Temperature	T_J, T_{stg}		-55 to 175	$^\circ\text{C}$
Soldering Temperature	T_L		260	

*By estimation.

Electrical Characteristics (T_c = 25°C unless otherwise specified)

Parameter	Symbol	Test Conditions	Min.	Typ.	Max.	Unit
DC Blocking Voltage	V _{DC}	I _R = 100 μA, T _J = 25°C	> 650			V
Forward Voltage	V _F	I _F = 4A, T _J = 25°C		1.5	1.8	V
		I _F = 4A, T _J = 175°C		1.8	2.1	V
Reverse Current	I _R	V _R = 650V, T _J = 25°C		1	30	μA
		V _R = 650V, T _J = 175°C		8	120	μA
Total Capacitive Charge	Q _C	I _F = 4A, di/dt = 300A/μs, V _R = 400V, T _J = 25°C		9		nC
Total Capacitance	C _j	V _R = 1V, T _J = 25°C, f = 1 MHz		173		
		V _R = 300V, T _J = 25°C, f = 1 MHz		17		pF
		V _R = 600V, T _J = 25°C, f = 1 MHz		16		
Capacitance Stored Energy	E _C	V _R = 400V		1.8		μJ

Thermal Resistance

Parameter	Symbol	Min.	Typ.	Max.	Unit
Thermal Resistance, Junction to Case	R _{θJC}		4.5		°C/W

Naming Rule

H3 D 065 S 004

Generation

H3 = 3rd Gen Discrete

Device Type

S = JBS diode (High Power) D = JBS diode (High Speed)

Breakdown Voltage

065 = 650V 120 = 1200V 170 = 1700V

Package Type

S = TO-252-2L K = TO-252-2L-1NC

Typical Current Rating

004 = 4A 006 = 6A 008 = 8A 010 = 10A 015 = 15A 020 = 20A

Recommended Solder Pad Layout

TO-252-2L, TO-252-2L-1NC

Parameter	Symbol	Typical	Unit
Length	A	6.00	mm
	B	6.50	
	C	3.00	
	D	1.40	
	E	6.25	
	F	2.30	
	G	2.30	

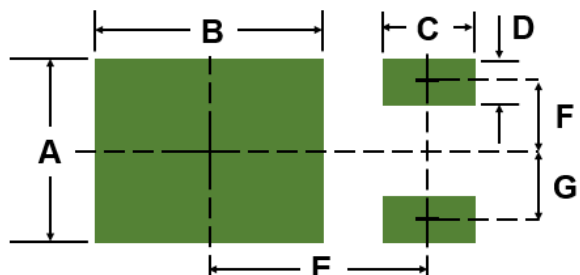

Typical Device Performance

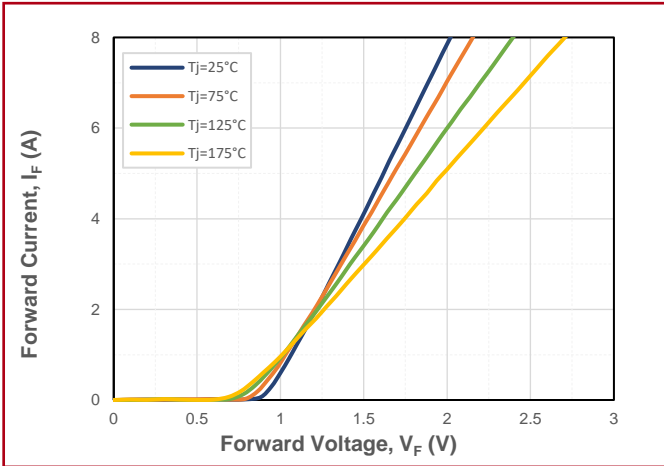

Fig.1 Forward Characteristics

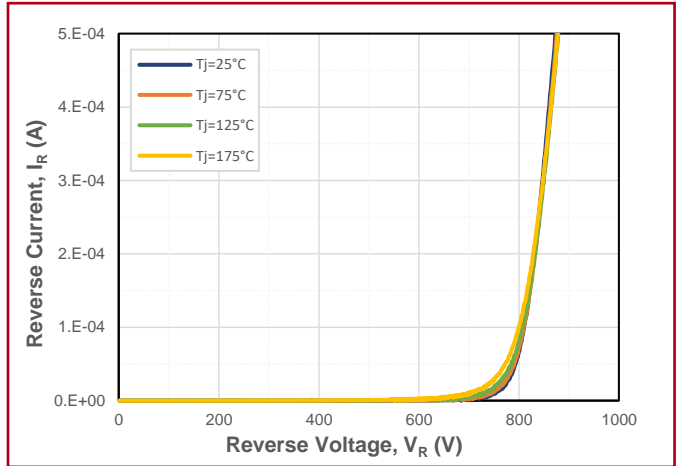

Fig.2 Reverse Characteristics

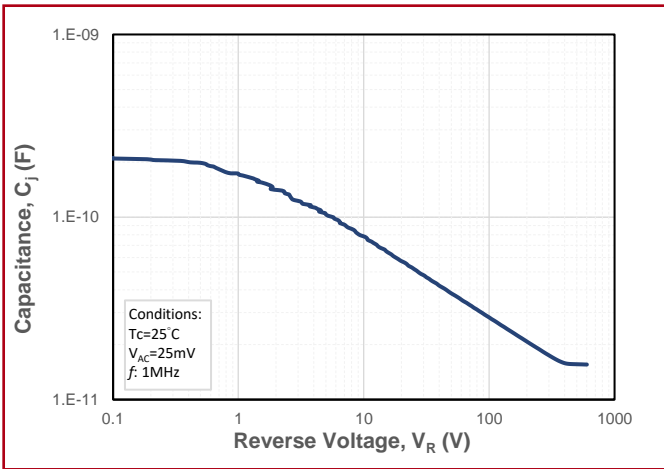

Fig.3 Junction Capacitance vs. Reverse Voltage

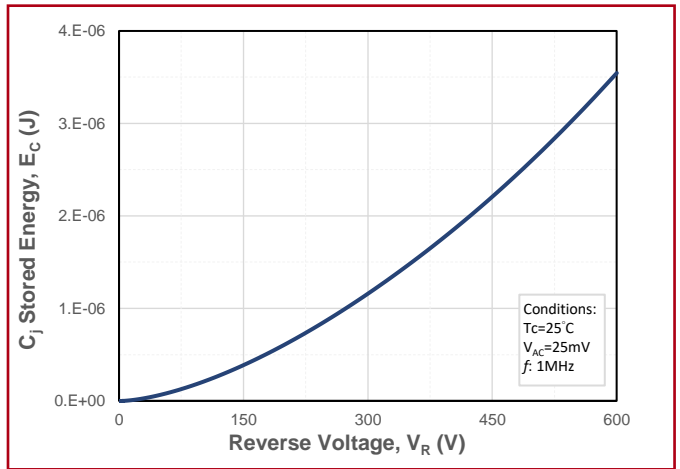

Fig.4 Capacitance Stored Energy

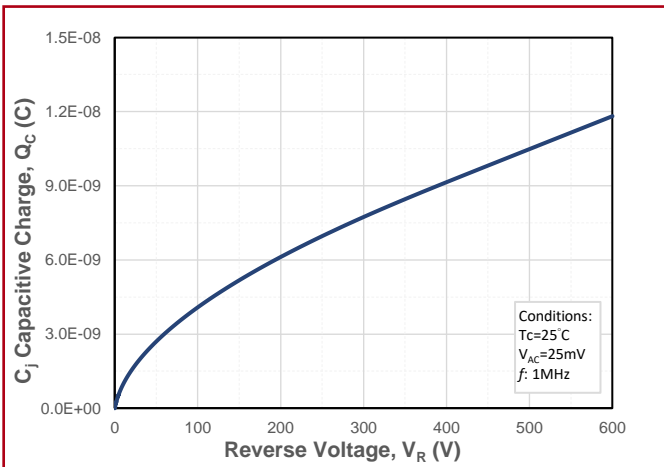

Fig.5 Recovery Charge vs. Reverse Voltage

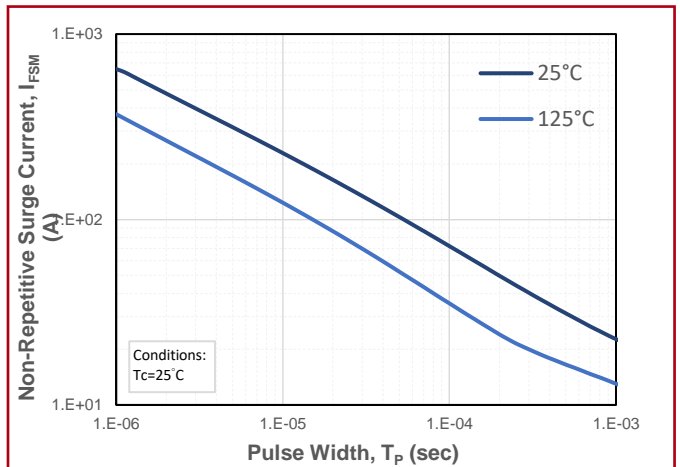

Fig.6 Non-Repetitive Peak Forward Surge Current (Pulse Mode)

Typical Device Performance

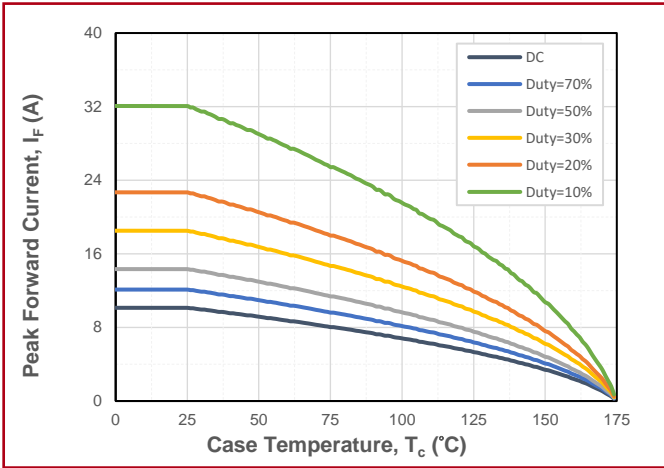

Fig.7 Maximum Forward Current Derating vs. Case Temperature

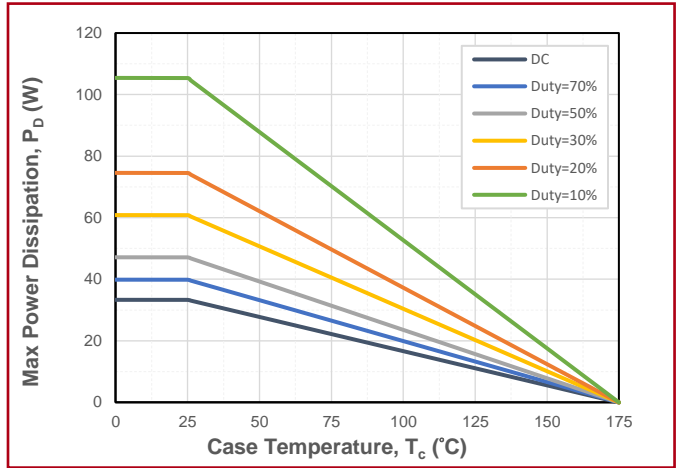

Fig.8 Maximum Power Dissipation Derating vs. Case Temperature

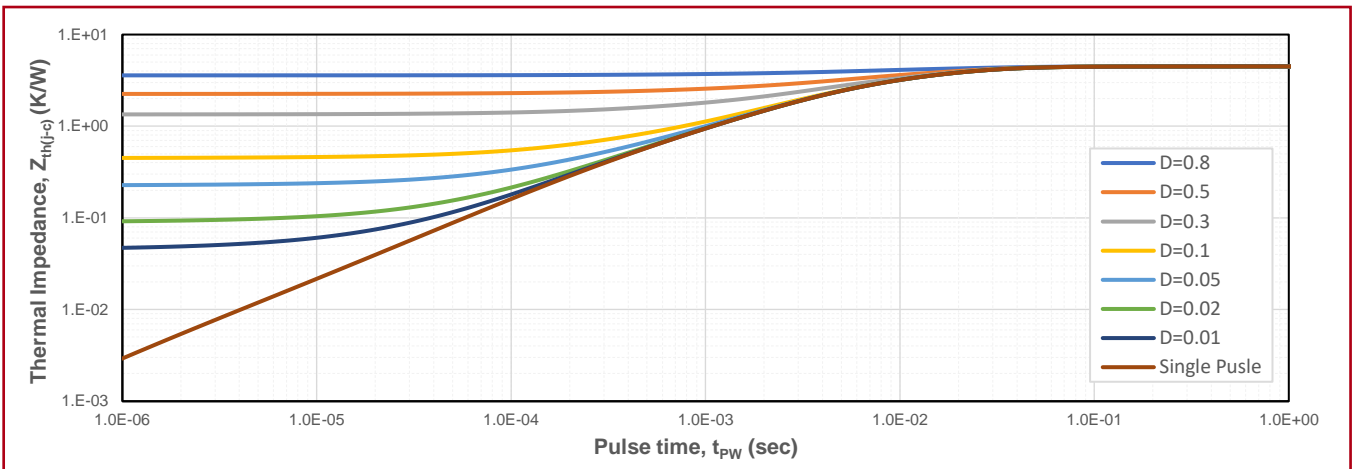
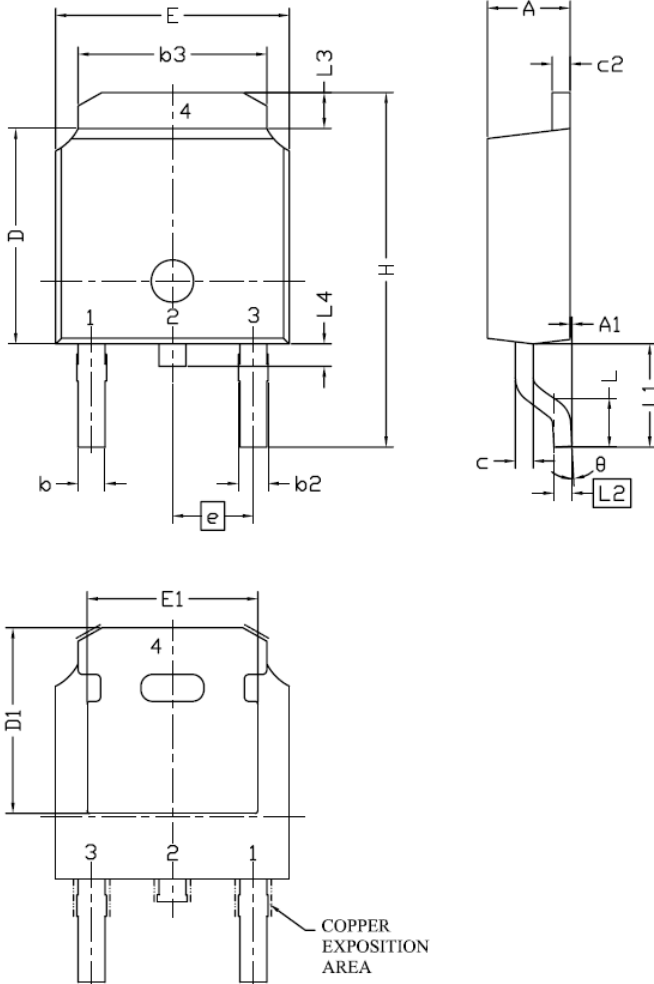

Fig.9 Transient Junction to Case Thermal Impedance

The information provided herein is subject to change without notice.

Package Dimensions (TO-252-2L, TO-252-2L-1NC)



Symbol	mm		
	Min.	Typ.	Max.
E	6.40	6.60	6.731
L	1.40	1.52	1.77
L1	2.743 REF		
L2	0.508 BSC		
L3	0.89	--	1.27
L4	0.00 REF (TO-252-2L) 0.83 REF (TO-252-2L-1NC)		
D	6.00	6.10	6.223
H	9.40	10.00	10.40
b	0.64	0.76	0.88
b2	0.77	0.84	1.14
b3	5.21	5.34	5.46
e	2.286 BSC		
A	2.20	2.30	2.38
A1	0	--	0.127
c	0.46	0.50	0.60
c2	0.46	0.50	0.58
D1	5.21	--	--
E1	4.40	--	--
θ	0°	--	10°

Note:

1. All Dimension Are In mm.
2. Package Body Sizes Exclude Mold Flash, Protrusion Or Gate Burrs. Mold Flash, Protrusion Or Gate Burrs Shall Not Exceed 0.10 mm Per Side.
3. Package Body Sizes Determined At The Outermost Extremes Of The Plastic Body Exclusive Of Mold Flash, Gate Burrs And Interlead Flash, But Including Any Mismatch Between The Top And Bottom Of The Plastic Body.
4. The Package Top May Be Smaller Than The Package Bottom.
5. Dimension "b" Does Not Include Dambar Protrusion. Allowable Dambar Protrusion Shall Be 0.10 mm Total In Excess Of "b" Dimension At Maximum Material Condition. The Dambar Cannot Be Located On The Lower Radius Of The Foot.