

## Product Summary

$V_R$	650V
$I_{F(110/139^\circ\text{C})}$	8.5A/6A
$Q_C$	13nC



# H3D065S006 H3D065K006

## Features

- Low Conduction and Switching Loss
- Zero Reverse Recovery
- Temperature Independent Switching Behavior
- Positive Temperature Coefficient Device
- High Surge Current Capability
- RoHS Compliant and Halogen Free
- Suitable for High Speed Application

## Circuit Diagram



## Benefits

- Higher System Efficiency
- Increase Parallel Device Convenience
- Enable High Temperature Application
- Allow High Frequency Operation
- Realize Compact and Lightweight Systems
- High Reliability

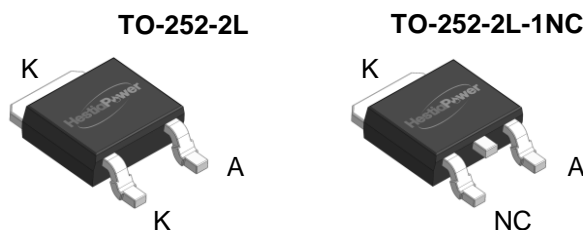

## Applications

- Switching Mode Power Supply
- PFC
- UPS
- Motor Drives
- Flywheel diode in Power Inverters
- Solar/Wind Renewable Energy

Part Number	Package	Marking
H3D065S006	TO-252-2L	H3D065S006
H3D065K006	TO-252-2L-1NC	H3D065K006

## Absolute Maximum Ratings ( $T_c = 25^\circ\text{C}$ unless otherwise specified)

Parameter	Symbol	Test Conditions	Value	Unit
Peak Repetitive Reverse Voltage	$V_{RRM}$	$T_J = 25^\circ\text{C}$	650	V
Peak Reverse Surge Voltage	$V_{RSM}$	$T_J = 25^\circ\text{C}$	650	V
DC Blocking Voltage	$V_R$	$T_J = 25^\circ\text{C}$	650	V
Continuous Forward Current	$I_F$	$T_C = 25^\circ\text{C}$	14	A
		$T_C = 110^\circ\text{C}$	8.5	
		$T_C = 139^\circ\text{C}$	6	
Non-Repetitive Peak Forward Surge Current	$I_{FSM}$	$T_C = 25^\circ\text{C}, T_p = 10\text{ ms}, \text{Half Sine Wave}$	42	A
		$T_C = 125^\circ\text{C}, T_p = 10\text{ ms}, \text{Half Sine Wave}$	38	
		$T_C = 25^\circ\text{C}, T_p = 10\text{ }\mu\text{s}, \text{Pulse}$	238	
Repetitive Peak Forward Surge Current	$I_{FRM}$	$T_C = 25^\circ\text{C}, T_p = 10\text{ ms}$ Half Sine Wave, $D = 0.1$	29	A
		$T_C = 125^\circ\text{C}, T_p = 10\text{ ms}$ Half Sine Wave, $D = 0.1$	25	
Power Dissipation	$P_D$	$T_C = 25^\circ\text{C}$	44.1	W
		$T_C = 125^\circ\text{C}$	14.7	
$I^2t$ value	$\int i^2 dt$	$T_C = 25^\circ\text{C}, T_p = 10\text{ ms}$	8.8	$\text{A}^2\text{s}$
Junction & Storage Temperature	$T_J, T_{stg}$		-55 to 175	$^\circ\text{C}$
Soldering Temperature	$T_L$		260	

## Electrical Characteristics (T<sub>c</sub> = 25°C unless otherwise specified)

Parameter	Symbol	Test Conditions	Min.	Typ.	Max.	Unit
DC Blocking Voltage	V <sub>DC</sub>	I <sub>R</sub> = 100 μA, T <sub>J</sub> = 25°C	> 650			V
Forward Voltage	V <sub>F</sub>	I <sub>F</sub> = 6A, T <sub>J</sub> = 25°C		1.5	1.8	V
		I <sub>F</sub> = 6A, T <sub>J</sub> = 175°C		1.8	2.1	V
Reverse Current	I <sub>R</sub>	V <sub>R</sub> = 650V, T <sub>J</sub> = 25°C		1.2	45	μA
		V <sub>R</sub> = 650V, T <sub>J</sub> = 175°C		12	180	μA
Total Capacitive Charge	Q <sub>C</sub>	I <sub>F</sub> = 6A, di/dt = 300A/μs, V <sub>R</sub> = 400V, T <sub>J</sub> = 25°C		13		nC
Total Capacitance	C <sub>j</sub>	V <sub>R</sub> = 1V, T <sub>J</sub> = 25°C, f = 1 MHz		249		
		V <sub>R</sub> = 300V, T <sub>J</sub> = 25°C, f = 1 MHz		26		pF
		V <sub>R</sub> = 600V, T <sub>J</sub> = 25°C, f = 1 MHz		24		
Capacitance Stored Energy	E <sub>C</sub>	V <sub>R</sub> = 400V		2.5		μJ

## Thermal Resistance

Parameter	Symbol	Min.	Typ.	Max.	Unit
Thermal Resistance, Junction to Case	R <sub>θ,JC</sub>		3.4		°C/W
Thermal Resistance, Junction to Ambient	R <sub>θ,JA</sub>				°C/W

## Naming Rule

**H3 D 065 S 006**

### Generation

H3 = 3<sup>rd</sup> Gen Discrete

### Device Type

S = JBS diode (High Power)    D = JBS diode (High Speed)

### Breakdown Voltage

065 = 650V    120 = 1200V    170 = 1700V

### Package Type

S = TO-252-2L    K = TO-252-2L-1NC

### Typical Current Rating

002 = 2A    004 = 4A    006 = 6A    008 = 8A    010 = 10A    015 = 15A

## Recommended Solder Pad Layout

### TO-252-2L, TO-252-2L-1NC

Parameter	Symbol	Typical	Unit
Length	A	6.00	mm
	B	6.50	
	C	3.00	
	D	1.40	
	E	6.25	
	F	2.30	
	G	2.30	

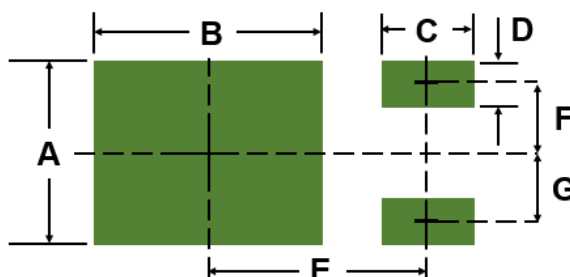

## Typical Device Performance

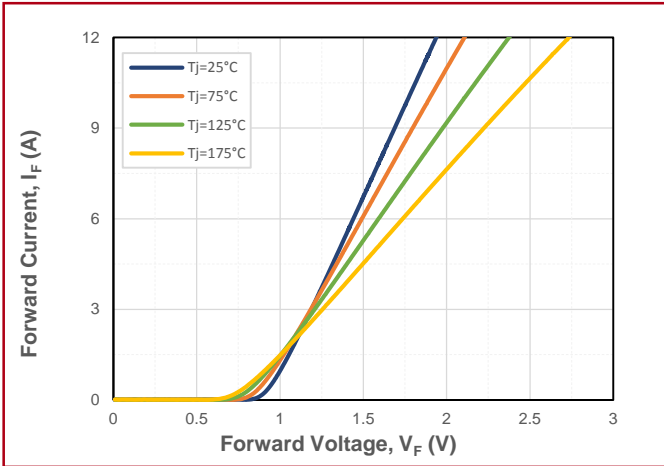

Fig.1 Forward Characteristics

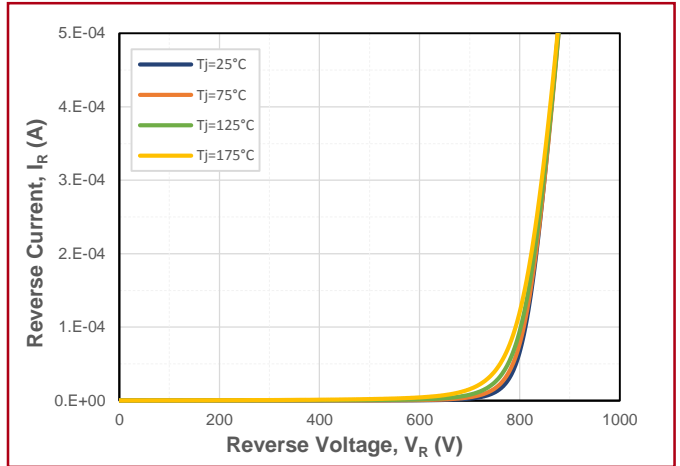

Fig.2 Reverse Characteristics

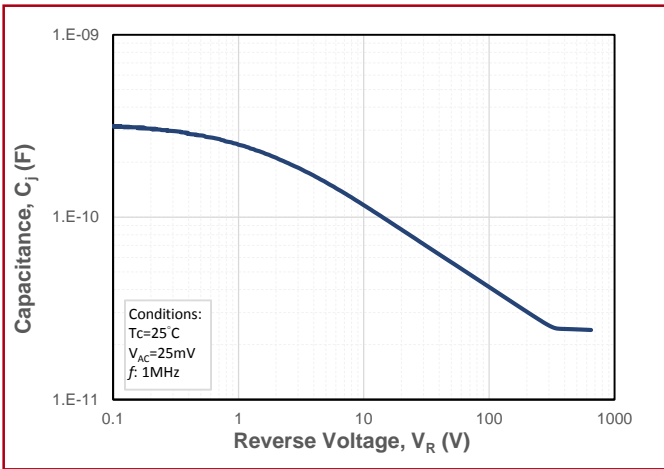

Fig.3 Junction Capacitance vs. Reverse Voltage

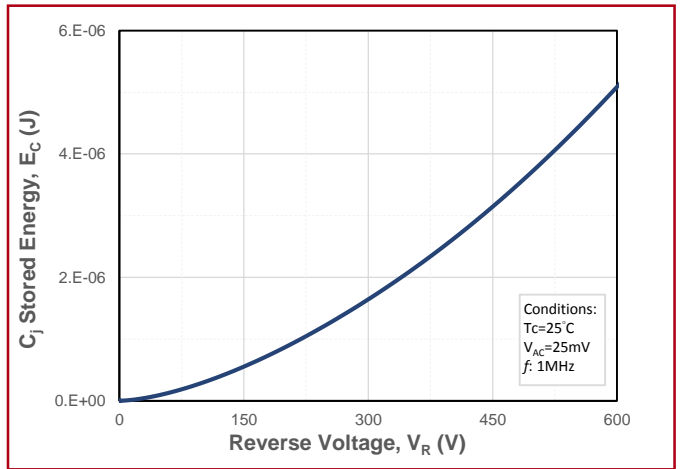

Fig.4 Capacitance Stored Energy

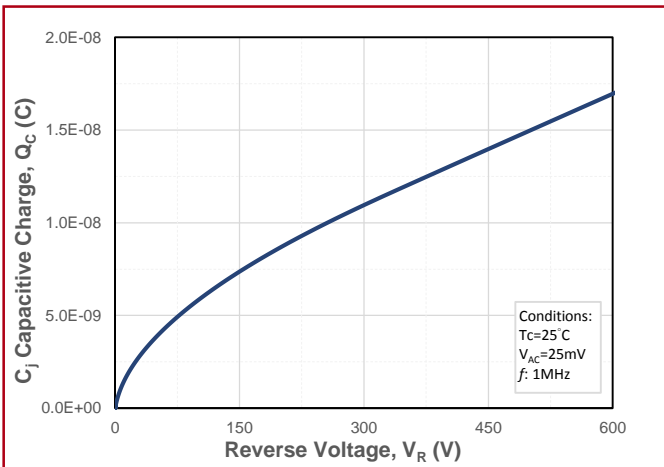

Fig.5 Recovery Charge vs. Reverse Voltage

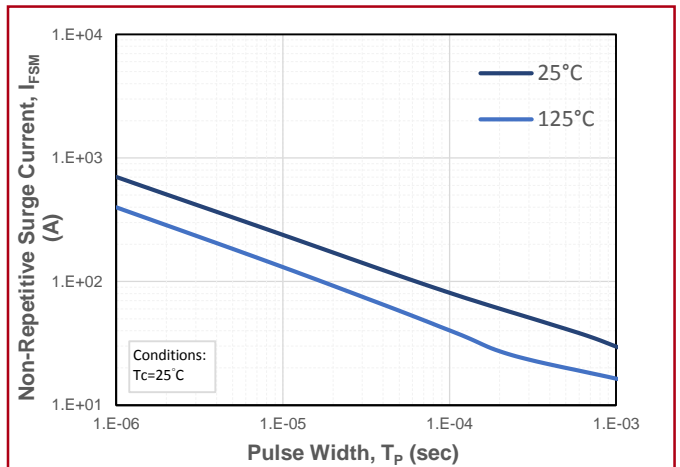
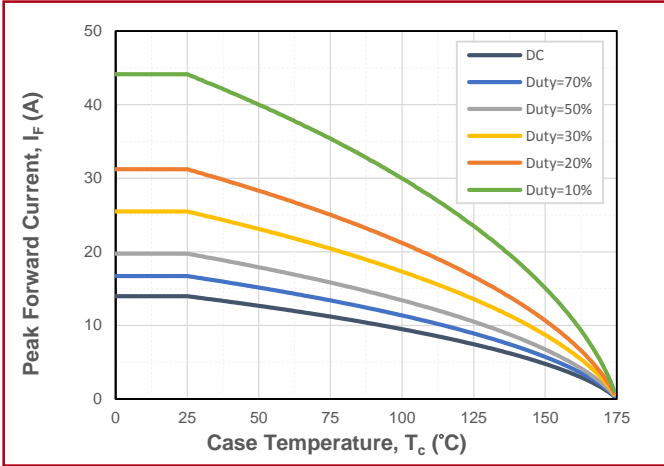
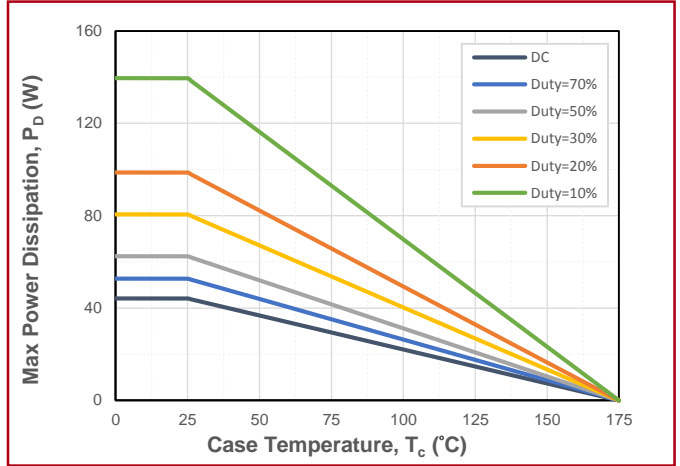

Fig.6 Non-Repetitive Peak Forward Surge Current (Pulse Mode)

### Typical Device Performance



**Fig.7 Maximum Forward Current Derating vs. Case Temperature**



**Fig.8 Maximum Power Dissipation Derating vs. Case Temperature**

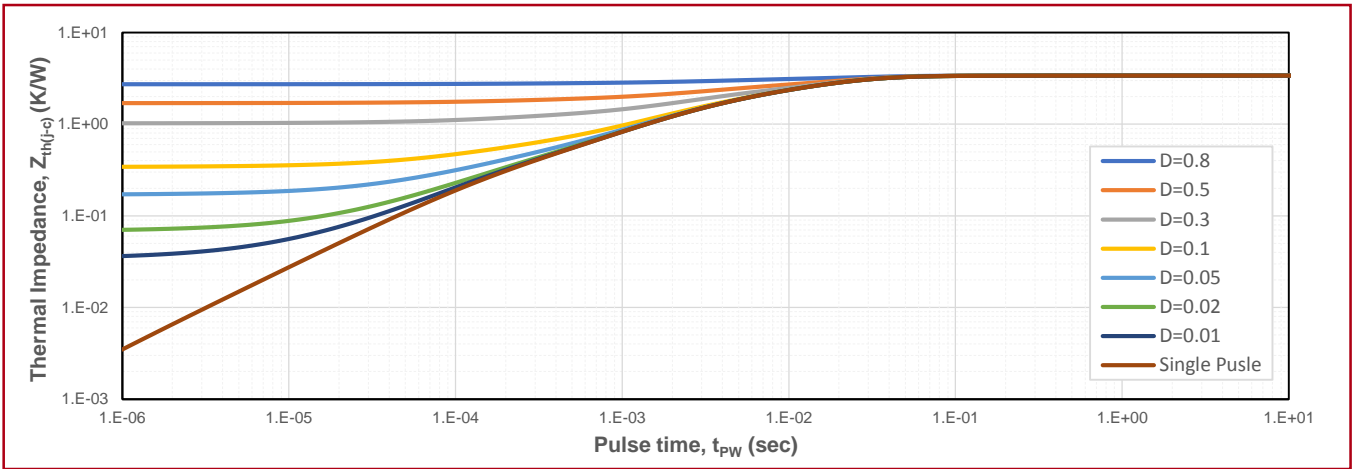

**Fig.9 Transient Junction to Case Thermal Impedance**

The information provided herein is subject to change without notice.

### Package Dimensions (TO-252-2L, TO-252-2L-1NC)

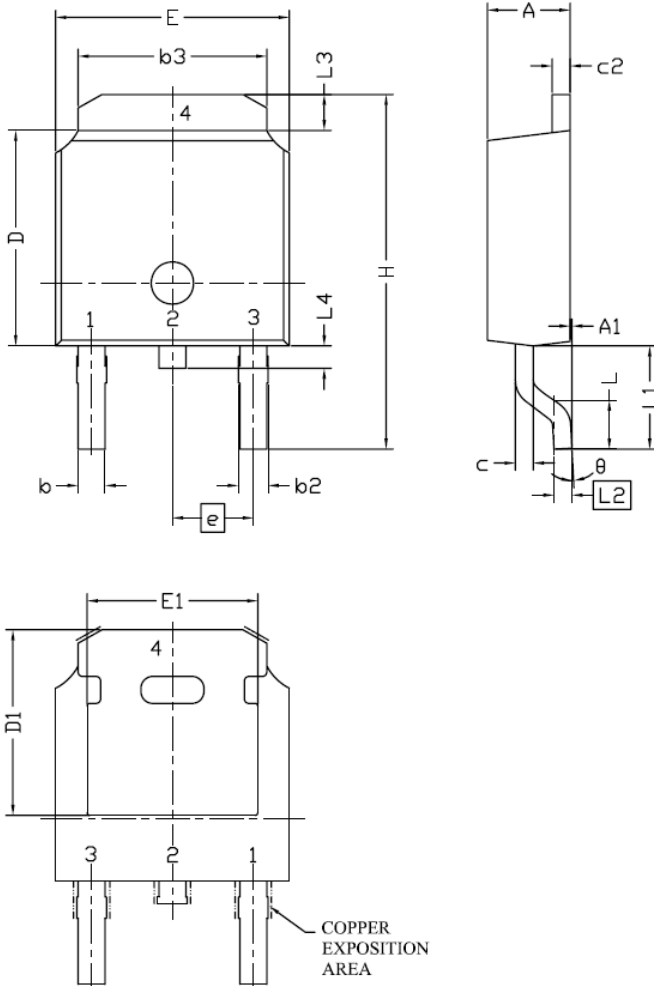

Symbol	mm		
	Min.	Typ.	Max.
E	6.40	6.60	6.731
L	1.40	1.52	1.77
L1	2.743 REF		
L2	0.508 BSC		
L3	0.89	--	1.27
L4	0.00 REF (TO-252-2L) 0.83 REF (TO-252-2L-1NC)		
D	6.00	6.10	6.223
H	9.40	10.00	10.40
b	0.64	0.76	0.88
b2	0.77	0.84	1.14
b3	5.21	5.34	5.46
e	2.286 BSC		
A	2.20	2.30	2.38
A1	0	--	0.127
c	0.46	0.50	0.60
c2	0.46	0.50	0.58
D1	5.21	--	--
E1	4.40	--	--
θ	0°	--	10°

Note:

1. All Dimension Are In mm.
2. Package Body Sizes Exclude Mold Flash, Protrusion Or Gate Burrs. Mold Flash, Protrusion Or Gate Burrs Shall Not Exceed 0.10 mm Per Side.
3. Package Body Sizes Determined At The Outermost Extremes Of The Plastic Body Exclusive Of Mold Flash, Gate Burrs And Interlead Flash, But Including Any Mismatch Between The Top And Bottom Of The Plastic Body.
4. The Package Top May Be Smaller Than The Package Bottom.
5. Dimension "b" Does Not Include Dambar Protrusion. Allowable Dambar Protrusion Shall Be 0.10 mm Total In Excess Of "b" Dimension At Maximum Material Condition. The Dambar Cannot Be Located On The Lower Radius Of The Foot.