

Product Summary

H3S065X006

Part Number	Package	Marking
H3S065X006	TO-220-FP-2L	H3S065X006

V_R	650V
$I_{F(110/140^\circ\text{C})}$	9A/6A
Q_C	14.7nC



Features

- Low Conduction and Switching Loss
- Zero Reverse Recovery
- Temperature Independent Switching Behavior
- Positive Temperature Coefficient Device
- High Surge Current Capability
- RoHS Compliant and Halogen Free
- Full Pack with Galvanic Isolation

Benefits

- Higher System Efficiency
- Increase Parallel Device Convenience
- Enable High Temperature Application
- Allow High Frequency Operation
- Realize Compact and Lightweight Systems
- High Reliability

Circuit Diagram

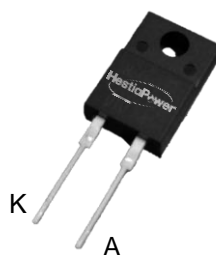

Applications

- Switching Mode Power Supply
- PFC
- UPS
- Motor Drives
- Flywheel diode in Power Inverters
- Solar/Wind Renewable Energy

Absolute Maximum Ratings ($T_C = 25^\circ\text{C}$ unless otherwise specified)

Parameter	Symbol	Test Conditions	Value	Unit
Peak Repetitive Reverse Voltage	V_{RRM}	$I_R = 100 \mu\text{A}$	650	V
Peak Reverse Surge Voltage	V_{RSM}	$T_J = 25^\circ\text{C}$	650	V
DC Blocking Voltage	V_R	$T_J = 25^\circ\text{C}$	650	V
Continuous Forward Current	I_F	$T_C = 25^\circ\text{C}$	14.8	A
		$T_C = 110^\circ\text{C}$	9	
		$T_C = 140^\circ\text{C}$	6	
Non-Repetitive Peak Forward Surge Current	I_{FSM}	$T_C = 25^\circ\text{C}$, $T_P = 10 \text{ ms}$, Half Sine Wave	58	A
		$T_C = 125^\circ\text{C}$, $T_P = 10 \text{ ms}$, Half Sine Wave	51	
		$T_C = 25^\circ\text{C}$, $T_P = 10 \mu\text{s}$, Pulse	405	
Repetitive Peak Forward Surge Current	I_{FRM}	$T_C = 25^\circ\text{C}$, $T_P = 10 \text{ ms}$ Half Sine Wave, $D = 0.1$	51	A
		$T_C = 125^\circ\text{C}$, $T_P = 10 \text{ ms}$ Half Sine Wave, $D = 0.1$	44	
Power Dissipation	P_D	$T_C = 25^\circ\text{C}$	42	W
		$T_C = 125^\circ\text{C}$	14	
I^2t value	$\int i^2 dt$	$T_C = 25^\circ\text{C}$, $T_P = 10 \text{ ms}$	16.5	A^2s
Junction & Storage Temperature	T_J, T_{stg}		-55 to 175	$^\circ\text{C}$
Soldering Temperature	T_L		260	
Mounting Torque	M_D	M3 or 6-32 screw	1.0	Nm

Electrical Characteristics (T_c = 25°C unless otherwise specified)

Parameter	Symbol	Test Conditions	Min.	Typ.	Max.	Unit
DC Blocking Voltage	V _{DC}	I _R = 100 μA, T _J = 25°C	> 650			V
Forward Voltage	V _F	I _F = 6A, T _J = 25°C		1.38	1.7	V
		I _F = 6A, T _J = 175°C		1.56	1.9	V
Reverse Current	I _R	V _R = 650V, T _J = 25°C		1.2	45	μA
		V _R = 650V, T _J = 175°C		12	180	μA
Total Capacitive Charge	Q _C	I _F = 6A, di/dt = 300A/μs, V _R = 400V, T _J = 25°C		14.7		nC
Total Capacitance	C _j	V _R = 0.1V, T _J = 25°C, f = 1 MHz		365		
		V _R = 200V, T _J = 25°C, f = 1 MHz		36		pF
		V _R = 400V, T _J = 25°C, f = 1 MHz		29		
Capacitance Stored Energy	E _C	V _R = 400V		2.8		μJ

Thermal Resistance

Parameter	Symbol	Min.	Typ.	Max.	Unit
Thermal Resistance, Junction to Case	R _{θJC}		3.5		°C/W
Thermal Resistance, Junction to Ambient	R _{θJA}				°C/W

Naming Rule

H3 S 065 X 006

Generation

H3 = 3rd Gen Discrete

Device Type

S = JBS diode (High Power) D = JBS diode (High Speed)

Breakdown Voltage

065 = 650V 120 = 1200V 170 = 1700V

Package

X = TO-220-FP-2L

Typical Current Rating

002 = 2A 004 = 4A 006 = 6A 008 = 8A 010 = 10A 012 = 12A

Recommended Solder Pad Layout

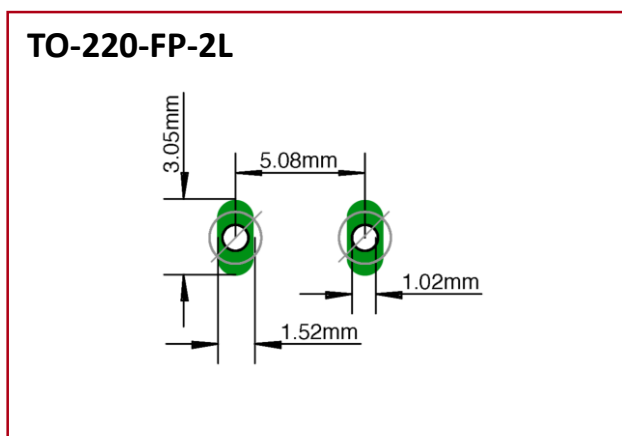

Typical Device Performance

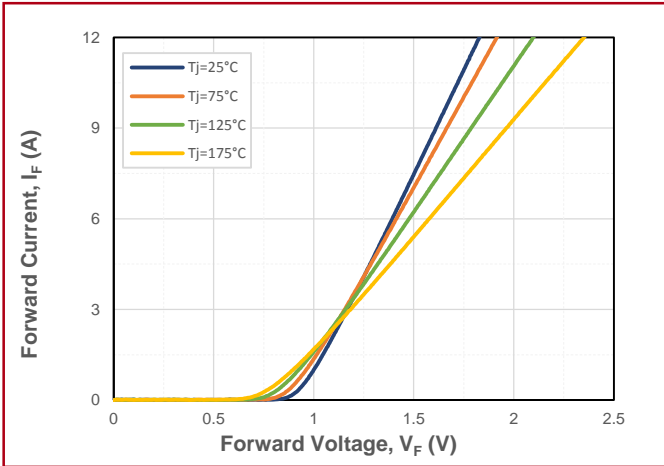

Fig.1 Forward Characteristics

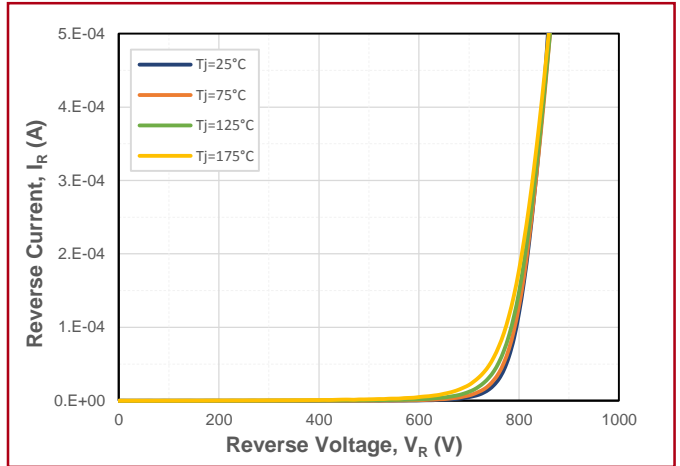

Fig.2 Reverse Characteristics

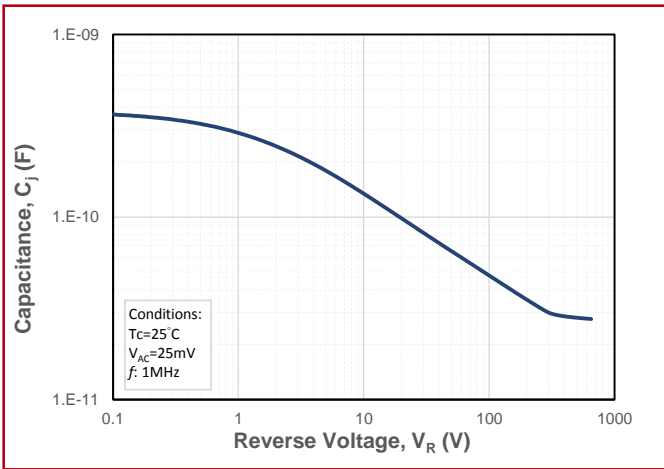

Fig.3 Junction Capacitance vs. Reverse Voltage

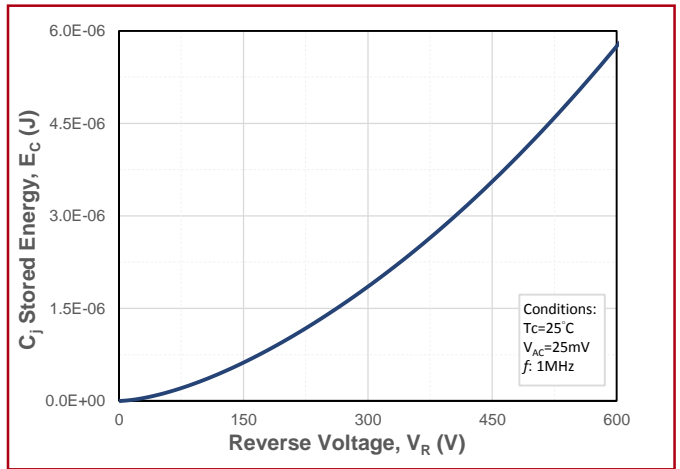

Fig.4 Capacitance Stored Energy

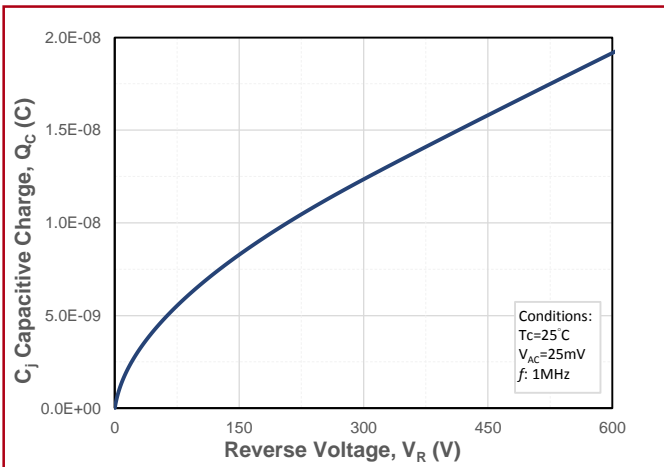

Fig.5 Recovery Charge vs. Reverse Voltage

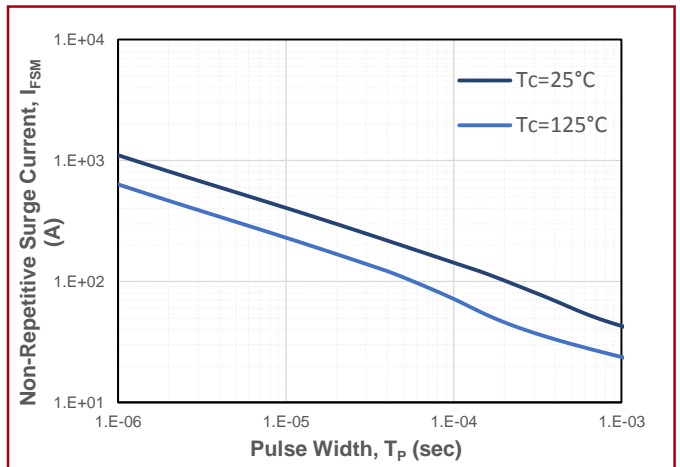

Fig.6 Non-Repetitive Peak Forward Surge Current (Pulse Mode)

Typical Device Performance

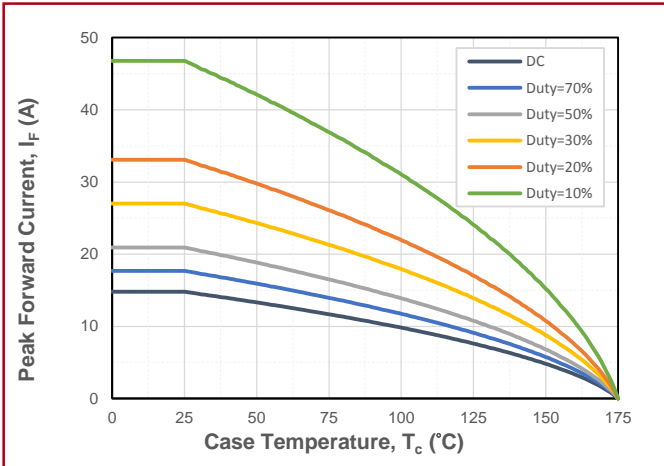

Fig.7 Maximum Forward Current Derating vs. Case Temperature

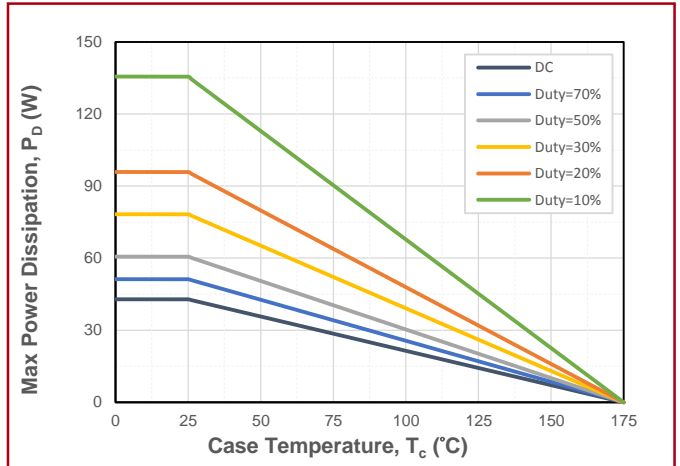

Fig.8 Maximum Power Dissipation Derating vs. Case Temperature

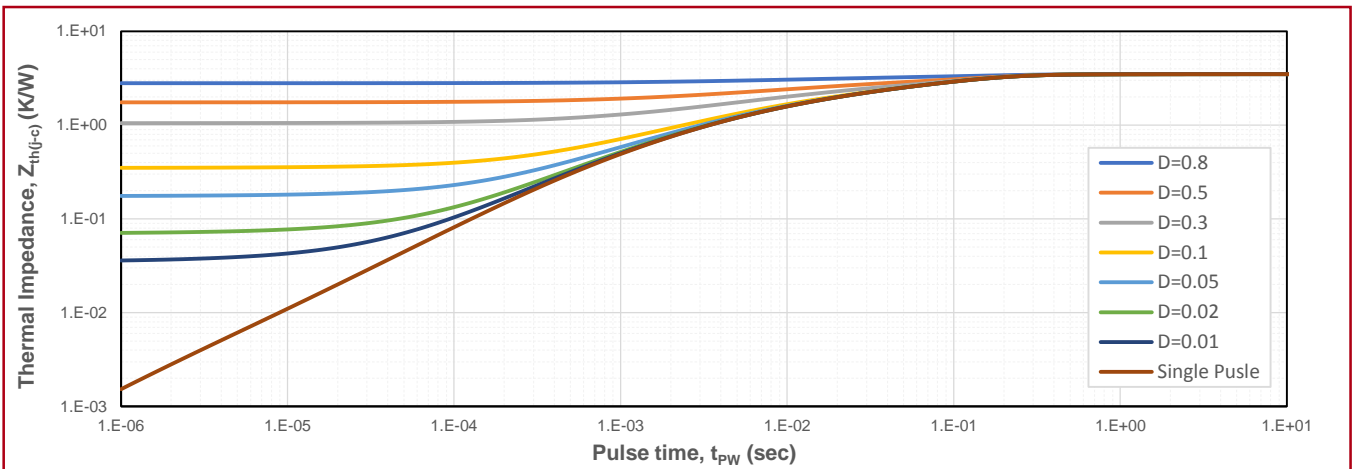
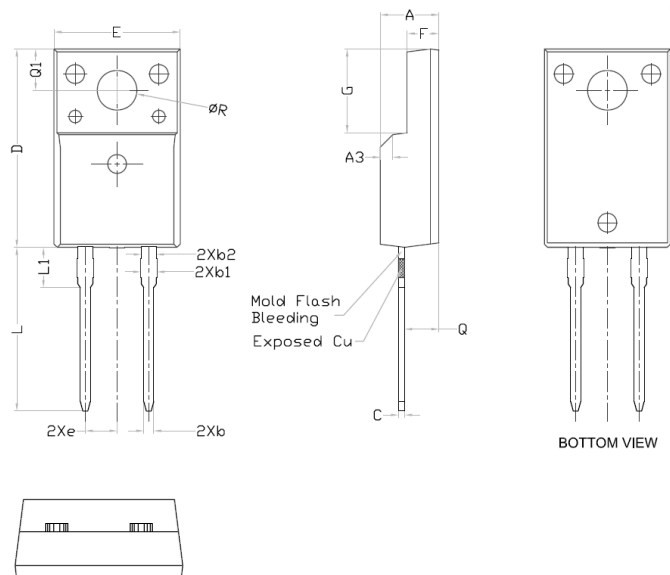

Fig.9 Transient Junction to Case Thermal Impedance

The information provided herein is subject to change without notice.

Package Dimensions (TO-220-FP-2L)



Symbol	mm		
	Min.	Typ.	Max.
A	4.60	4.70	4.80
b	0.70	0.80	0.91
b1	1.20	1.30	1.47
b2	1.10	1.20	1.30
C	0.45	0.50	0.63
D	15.80	15.87	15.97
e	2.54		
E	10.00	10.10	10.30
F	2.44	2.54	2.64
G	6.50	6.70	6.90
L	12.90	13.10	13.30
L1	3.13	3.23	3.33
Q	2.65	2.75	2.85
Q1	3.20	3.30	3.40
ϕR	3.08	3.18	3.28

Note:

1. All Dimension Are In mm.
2. Package Body Sizes Exclude Mold Flash And Burrs
Mold Flash Should Be Less Than 6 Mil.